

Getting Started Manual

Segway Personal Transporter (PT) i2, x2

 **WARNING**

RISK OF DEATH OR SERIOUS INJURY.

Whenever you ride the Segway PT, you risk death or serious injury from loss of control, collisions, and falls. To ride safely, you must read and follow all instructions and warnings in the User Materials.

Getting Started Manual Segway® PT i2, x2

Copyright, Trademarks, and Contact Information

Copyright © 2006 Segway Inc. All rights reserved.

Trademarks

Segway Inc. (“Segway”) owns a number of trademarks including, but not limited to, Segway and the Segway “flyguy” logo that have been registered in the United States and in other countries. Those trademarks followed by ® are registered trademarks of Segway. All other marks are trademarks or common law marks of Segway. Failure of a mark to appear in this guide does not mean that Segway does not use the mark, nor does it mean that the product is not actively marketed or is not significant within its relevant market. Segway reserves all rights in its trademarks. All other trademarks are the property of their respective companies.

Contact Information

For support, please contact the company from which you bought the products. For a listing of Authorized Segway Dealers and Distributors, refer to the Segway website at: <http://www.segway.com>.

Segway Customer Care: 866.4SEGWAY (866.473.4929)

Fax: 603.222.6001

E-mail: technicalsupport@segway.com

Website: <http://www.segway.com>

Part Number: 20601-00001aa

Contents

Preface

About This Manual	xii
The Risk of Injury	xiii
Learning to Ride the Segway PT	xiv
Related User Materials	xv
Conventions	xvii
Introduction	1
Safety First!	2
Segway PT Components	5
Using the InfoKey Controller	8
InfoKey Controller Buttons and Display	9
Setting Up Your Segway PT	12
Unpacking Your Segway PT	12
Assembling Your Segway PT	14
Attaching the Handlebar	15
Attaching the LeanSteer Frame	18

Installing the Console Trim	20
Installing the InfoKey Controller Dock	21
Attaching the Dock Adapter	23
Docking the InfoKey Controller	23
Preparing the LeanSteer Frame	24
Adjusting the Handlebar Height	25
Charging the Batteries	27
Charge Indicator Lights	32
Safety Alerts	34
Speed Limiter	35
Stick Shake Warning	38
Safety Shutdown	42
Understanding Balance Mode	47
Understanding the Rider Detect Sensors	48
Riding Guidelines	51
Riding Form	51
Avoiding Hazards	53
Avoiding Slips	54
Avoiding Trips	56
Avoiding Tips	57
Riding Your Segway PT	59
Step 1: Preparing for Your Ride	60
Step 2: Powering On the Segway PT	63
Step 3: Confirming the Beginner Setting	65

Step 4: Before Stepping On	68
Step 5: Stepping On	70
Step 6: Moving Forward and Backward	77
Step 7: Stopping.....	80
Step 8: Turning the Segway PT	84
Turning In Place	84
Turning While Moving	86
Step 9: Stepping Off.....	87
Step 10: Securing Your Segway PT.....	93
Step 11: Powering Off the Segway PT.....	96
Practice Riding	97
Navigating Terrain.....	100
Terrain Compensation	100
Navigating Stairs and Curbs	102
Riding Etiquette.....	106
Safety Tips and Guidelines.....	108
Report All Incidents	124
Consult the Reference Manual and Website	124

Preface

Congratulations on the purchase of your new Segway® Personal Transporter (PT)!

The Segway PT is the standard term used to refer to the self-balancing Segway products described in this manual. Each Segway PT model (i2 or x2) is different, but the fundamentals found in this manual apply to both models.

About This Manual

This Getting Started Manual is intended to help you set up and use your Segway PT. It provides basic information to get you started quickly. More comprehensive information is provided in the Reference Manual.

It is important that you adhere to all safety warnings and cautions that appear throughout your Segway PT User Materials and that you use good judgment when you ride your Segway PT.

The Risk of Injury



WARNING!

Whenever you ride the Segway PT, you risk injury from loss of control, collisions, and falls. It is your responsibility to learn how to safely ride the Segway PT in order to reduce this risk. This Getting Started Manual, the Reference Manual, and the Safety Video (DVD) are designed to help you learn safe riding techniques.

For a list of Authorized Segway Dealers and Distributors, refer to www.segway.com.

Learning to Ride the Segway PT

Segway wants you to be safe and enjoy learning how to ride your Segway PT. Think about how you learned to ride a bike, drive a car, ski, or do just about anything else involving transportation. You probably had somebody help you learn. You started in a safe location. You started slowly. All these techniques apply to the Segway PT.

If you carefully follow all the instructions and warnings in this Getting Started Manual, the Reference Manual, and the Safety Video, you should be able to teach yourself how to ride the Segway PT, but you must be careful. We strongly recommend that you have a spotter who has studied all the instructions and warnings in this Getting Started Manual and the Safety Video for the first time you ride your Segway PT. Prior to each ride, ensure the Tires are well maintained and there are no loose components.

Please do not take risks.

Related User Materials

- **Reference Manual** - The Segway PT Reference Manual provides information such as safety alerts, operating and maintaining the Segway PT, Battery information, and troubleshooting and servicing instructions.
- DVD that contains:
 - **PDF files of each manual.** Segway provides an electronic copy of the Reference Manual and the Getting Started Manual on DVD for your convenience. The content of the electronic copy is the same as the printed books. You will need Adobe Reader[®] to access the PDF files.



- **Safety Video.**

The Safety Video is included on the same DVD as the manuals. It provides important information on how to use your Segway PT. To reduce risk of injury, you must watch and follow all instructions and warnings in the Safety Video before you ride.

DVDs are shipped in NTSC format for viewing in North America (USA, Canada, Mexico) and Japan and in PAL format for viewing in most parts of Europe, Asia, Australia and New Zealand.

Conventions

The following conventions are used throughout this manual:

 WARNING!	Warns you about actions that may result in personal injury.
 CAUTION	Cautions you about actions that may result in operational issues or physical damage to the Segway PT.
 NOTE:	Identifies important points, helpful hints, special circumstances, or alternative methods.
▶ ▶	Indicates a reference to another section of this document or to the Reference Manual.

Introduction

This manual:

- Describes safety and warning information to help make every ride you take safe and fun.
- Identifies the components of the Segway PT.
- Discusses assembly procedures.
- Describes safety alerts.
- Provides details for using the Segway PT (including preparing to ride and taking your first ride).
- Describes riding techniques.

Safety First!

This section provides safety and warning statements that you should be aware of before you use your Segway PT.



WARNING!

RISK OF DEATH OR SERIOUS INJURY

Whenever you ride the Segway PT, you risk death or serious injury from loss of control, collisions, and falls. To reduce risk of injury, you must read and follow all instructions and warnings in the User Materials.

**WARNING!**

Always wear a helmet when riding. Use an approved bicycle or skateboard helmet that fits properly with the chin strap in place, and provides protection for the back of your head.

**WARNING!**

Avoid obstacles and slippery surfaces that could result in a loss of balance or traction and cause a fall.



WARNING!

Pay attention to all warnings and alerts from the Segway PT. They indicate unsafe operating conditions. You must learn about and understand the Segway PT Safety Alerts described in the User Materials and respond as instructed.

Segway PT Components

Your Segway PT includes the following components:

- InfoKey™ Controller
- InfoKey Controller Dock
- Handlebar
- LeanSteer™ Frame
- Tire/Wheel Assembly and Fenders
- Console with Charge and Balance Indicator Lights
- Console Trim
- Mats
- Powerbase
- Batteries



WARNING!

All Segway PT parts must be properly installed. Never attempt to stand on a Segway PT without the LeanSteer Frame attached and secured. Using your Segway PT without all parts properly installed could damage your Segway PT and result in serious injury from loss of control, collisions, and falls.



WARNING!

Do not modify the Segway PT. Modifications to the Segway PT without the prior written approval of Segway could interfere with the operation of the Segway PT, could result in serious injury and/or damage, and could void the Segway PT Limited Warranty.

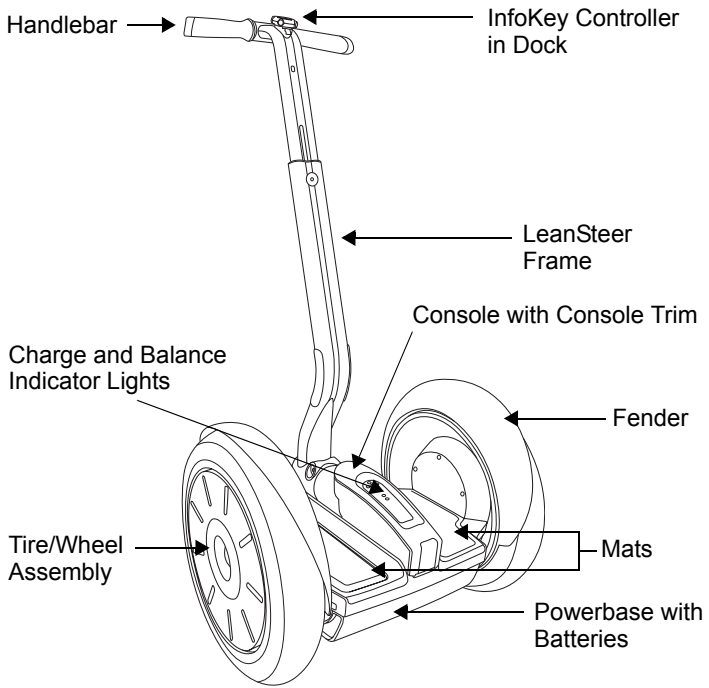

Using the InfoKey Controller

You use the InfoKey Controller to communicate with the Segway PT. The InfoKey Controller has four buttons around the outer edge and a display in the center:

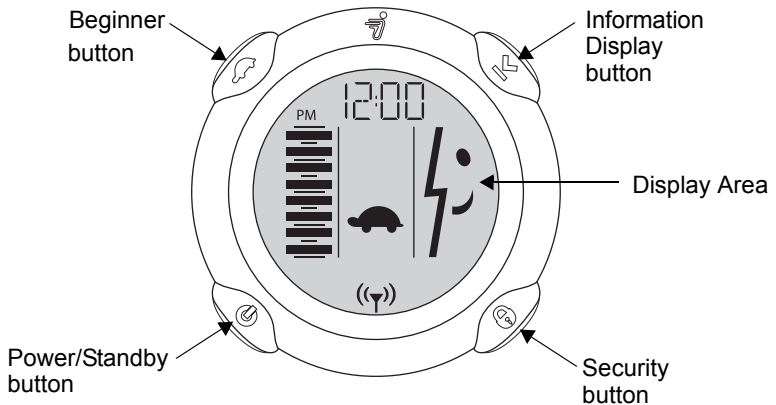

InfoKey Controller Buttons and Display



Power/Standby Button

The Power/Standby button allows you to power the Segway PT on and off and switch from Balance Mode to Standby Mode.



Beginner Button

The Beginner button allows you to toggle the Beginner Setting on and off and illuminate the Backlight. When the Beginner Setting is on, the top forward speed and steering rate are slower. You must learn to ride using the Beginner Setting.



Information Display Button

The Information Display button:

- Allows you to scroll through information including time, date, speed, average speed, trip distance, and odometer.
- Allows you to set time, speed/distance format, date and reset the average speed and trip distance.



Security Button

The Security button allows you to activate the security function (alarm).

Display Area

The Display Area displays time, date, speed, average speed, trip distance and odometer.

- ▶ ▶ For additional information, see “**The InfoKey Controller**” in the Reference Manual.

Setting Up Your Segway PT

This section describes what is included with your Segway PT and instructions for assembly.

Unpacking Your Segway PT

The following items/parts ship with your Segway PT:

- Handlebar
- LeanSteer Frame
- LeanSteer Frame Fastener and Wedge Clamps
- Console Trim
- Segway PT Powerbase
- Getting Started Manual
- Reference Manual
- Safety Video (DVD)

- InfoKey Controller
- InfoKey Controller Dock and Fastener
- Segway PT Limited Warranty (United States only)
- Wrench Set (3mm and 5mm hex)
- Power Cord (for charging the Batteries)

Assembling Your Segway PT

This section provides instructions for assembling your Segway PT.



WARNING!

Always shut down your Segway PT and unplug the AC Power Cord before performing any maintenance or installing any part or accessory.



CAUTION

Adhere to torque specifications when tightening fasteners. Over-tightening or under-tightening fasteners can result in damage or malfunction.

- ▶ ▶ If your Segway PT is already assembled, you may skip this section and go to “**Adjusting the Handlebar Height**” on **page 25**.

Attaching the Handlebar

Tool Required: Torque wrench with 3mm bit.

To attach the Handlebar to the LeanSteer Frame:

1. Make sure the Segway PT is unplugged and powered off.
2. Align the Handlebar in place against the LeanSteer Frame using the alignment guides.
3. Position the Handlebar Clamp against the Handlebar.

4. Insert the 3 fasteners through the Handlebar Clamp into the LeanSteer Frame.
5. Using the 3mm hex wrench, alternate between the 3 fasteners, evenly tightening in small increments.
6. Check to ensure that the gap between the Handlebar Clamp and the LeanSteer Frame is even, and the same between the top and bottom. Tighten to 6.0 N-m (4.4 ft-lbf).

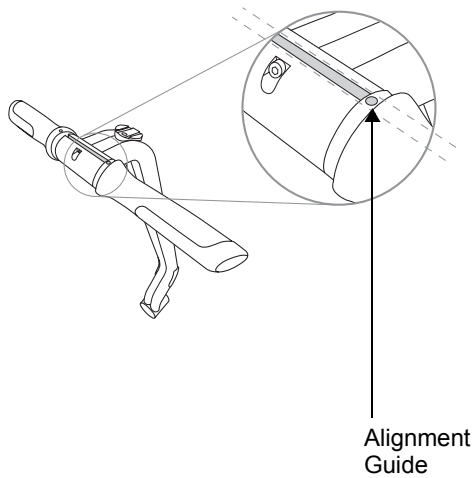
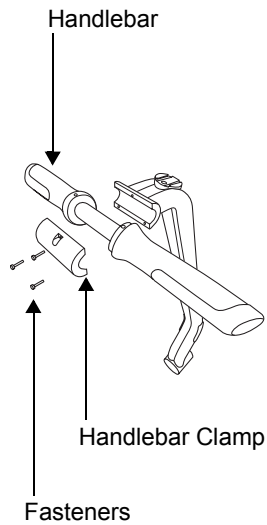

Attaching the LeanSteer Frame

Tool Required: Torque wrench with 5mm bit.

To attach the LeanSteer Frame to the Powerbase:

1. Slide the LeanSteer Frame onto the Pivot Base Assembly.

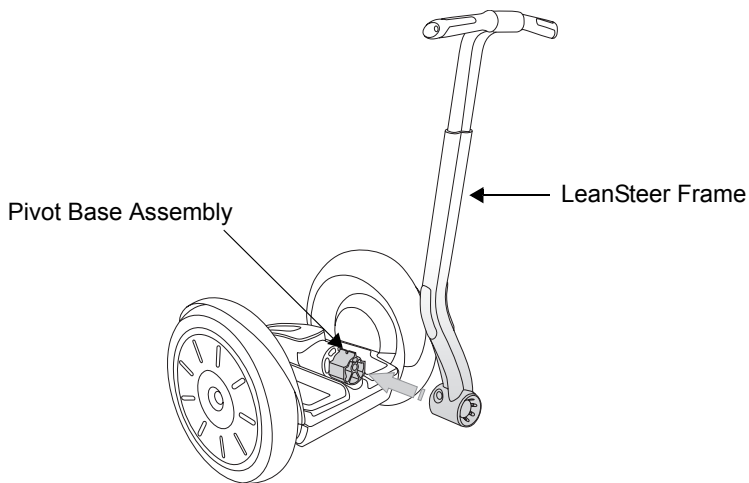

2. Install each Wedge Clamp, curved side facing down, on either side of the LeanSteer Frame base.
3. Loosely thread the fastener through the Wedge Clamps.
4. Prior to tightening the fastener, visually check that the Handlebar is straight and centered. If it is not straight and centered, adjust the LeanSteer Frame.
5. Tighten the fastener to 11.0 N-m (8.1 ft-lbf).

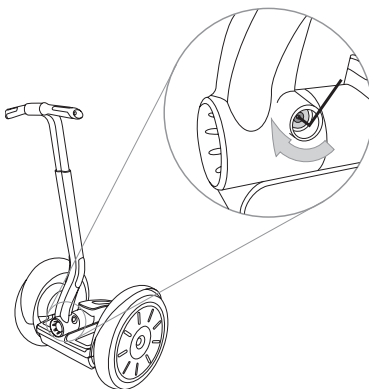

Installing the Console Trim

Tool Required: None

To install the Console Trim:

1. Make sure the Segway PT is unplugged and powered off.
2. Press the Console Trim in place over the Console.
3. Snap the rear part of the Console Trim in place.

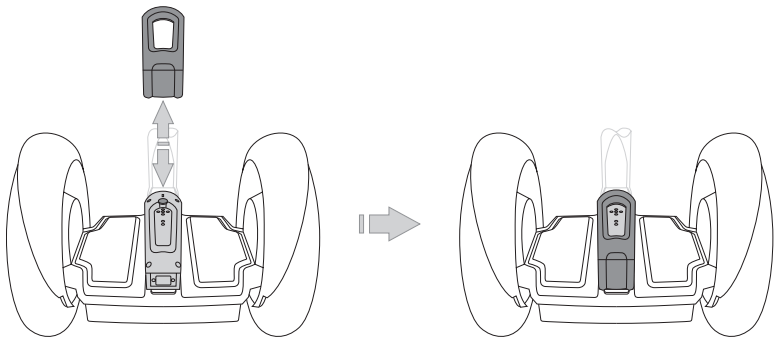

Installing the InfoKey Controller Dock

Tool Required: Torque wrench with 3mm bit.



NOTE:

You should install the InfoKey Controller Dock and mount the InfoKey Controller into the Dock prior to riding. Always pay attention and look ahead when you are riding.

To install the InfoKey Controller Dock:

1. Place the InfoKey Controller Dock against the upper LeanSteer Frame with the Release Tab oriented at the bottom.
2. Thread the 3mm fastener through the hole in the top of the InfoKey Controller Dock and into the upper LeanSteer Frame.
3. Tighten the fastener to 2.0 N-m (18 in-lbf)

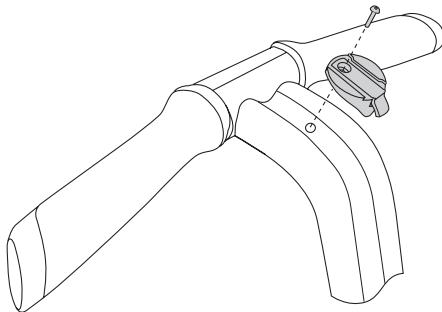

Attaching the Dock Adapter

Tool Required: None.

To install the InfoKey Controller Dock Adapter, screw the adapter to the underside of the InfoKey Controller.

Docking the InfoKey Controller

Tool Required: None.

To Dock the InfoKey Controller:

1. Make sure the InfoKey Controller Dock Adapter is installed.
2. Slide the InfoKey Controller up into the InfoKey Controller Dock.

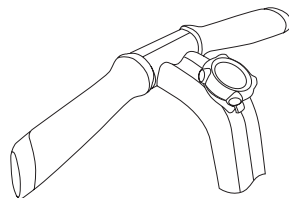
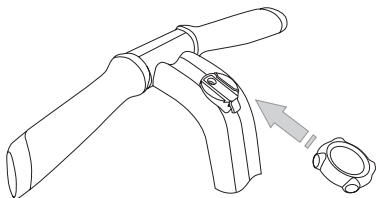

Preparing the LeanSteer Frame

Tool Required: 3mm hex wrench, Torque wrench with 3mm bit.

The LeanSteer Frame is collapsed to its shortest possible length when it is shipped. Assembly is required before adjusting the Handlebar height for the first time. To extend and assemble the LeanSteer Frame:

1. Remove the Height Adjustment fastener and clamp using the 3mm hex wrench.
2. Extend the upper bar of the LeanSteer Frame by sliding it up from its storage position until the slot for the Height Adjustment fastener is visible.
3. Reinstall the Height Adjustment clamp and 3mm fastener.
4. Tighten to 2.0 N-m (18 in-lbf).

Adjusting the Handlebar Height

Tool Required: 3mm hex wrench. Torque wrench with 3mm bit.

To adjust the Handlebar height:

1. Loosen the Height Adjustment fastener.

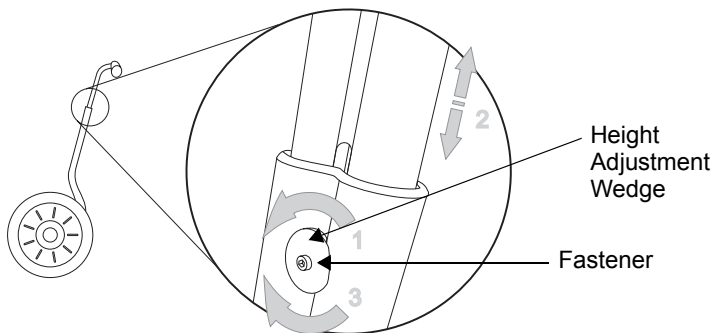

2. Adjust the height of the upper LeanSteer Frame by pulling up on the Handlebar until the Handlebar is just above your elbow or higher while you are standing on the floor and the Powerbase is level. You can adjust as necessary for comfort.
3. Tighten the Height Adjustment fastener to 2.0 N-m (18in-lbf).



NOTE:

Adjusting the Handlebar to the correct height is important for both safety and comfort.

Charging the Batteries



NOTE:

The Segway PT Batteries should be charged for at least 12 hours before the first use.

Two Li-ion Batteries come preinstalled on your Segway PT, and are located on the underside of the Powerbase.

To maximize the performance of your Segway PT Batteries, fully charge your Batteries for at least 12 hours, once a month, or after every 12 hours of operation—whichever comes first. Charge your Batteries only when they are within the specified charging temperature range.

- ▶ ▶ For additional information, see “**Specifications for the Batteries**” in the Reference Manual.

Charge the Batteries of your new Segway PT for at least 12 hours as soon as possible after you receive it.

Always charge Batteries in a clean, dry location, free of debris.

To charge the Batteries:

1. Open the Charge Port of your Segway PT.
2. Verify that the Charge Port is dry.



WARNING!

Do not insert the plug if the Charge Port is wet.

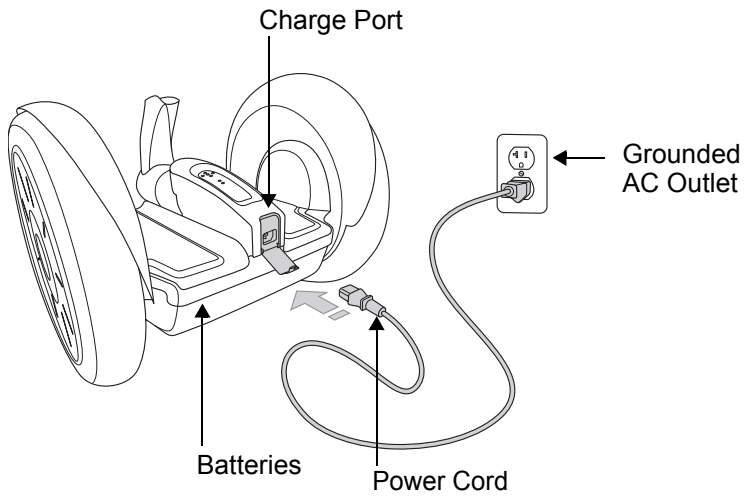

3. Plug one end of the Power Cord into a grounded AC outlet (100 V~ to 240 V~; 50 Hz or 60 Hz). The Power Cord should be properly grounded.
4. Plug the other end of the Power Cord (provided with your Segway PT) into the Charge Port of your Segway PT.
5. Verify that the Charge Indicator lights are green.



NOTE:

You may need an adapter to fit into International power outlets in order to use the supplied power cord in your country.

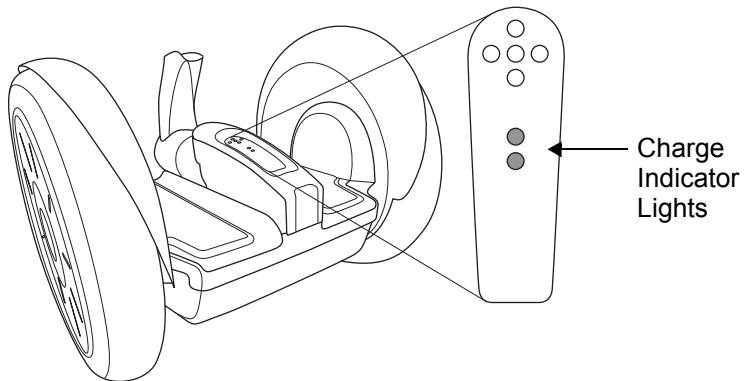

Charge Indicator Lights

This section defines the status of the Charge Indicator lights on the Console:

- Solid green indicates the Batteries are charging.
- Flashing green indicates charge is complete.
- Red indicates a fault condition.
- ▶ ▶ For more information on the Charge Indicator lights, see “**Battery Charge Indicator Lights**” in the Reference Manual.

 **CAUTION**

Failure to charge the Batteries could result in permanent damage to them. Do not store your Segway PT or Batteries without fully charging the Batteries for at least 12 hours, once a month. Left unplugged, the Batteries could fully discharge over time, causing permanent damage.

The Reference Manual contains important instructions regarding Battery charging. Follow those instructions to prevent Battery damage and to maximize Battery life.

Safety Alerts

The Segway PT is equipped with multiple safety alerts. It is important to understand these alerts before you attempt to ride your Segway PT.



WARNING!

Read and follow all the instructions in the Getting Started Manual and the Reference Manual and watch the Safety Video for important safety information about the Speed Limiter, Stick Shake, and Safety Shutdown alerts.



NOTE:

Not every safety issue triggers an alert. For additional safety tips and guidelines, see **“Avoiding Hazards” on page 53.**

Speed Limiter

When you approach the maximum allowed speed for a given situation, the Segway PT will push the Handlebar back to slow you down. This is called the Speed Limiter.

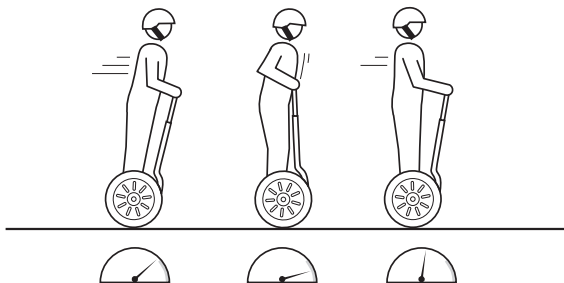

The Segway PT's Speed Limiter is an alert that you are moving too fast. When the Segway PT pushes the Handlebar back, **stop leaning forward and slow down**. Always leave a gap between yourself and the Handlebar.

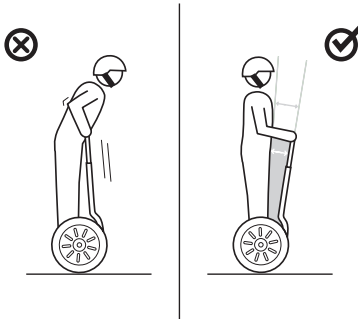



WARNING!

While the Segway PT is designed to keep you upright under a variety of conditions, you can overpower the balancing capability of your Segway PT by aggressively leaning into and ignoring the Speed Limiter.

The speed at which the Handlebar pushes back depends on a variety of factors including riding style, terrain, payload, whether or not Beginner Setting is selected on the InfoKey Controller, Battery condition, foot positioning, and other factors.

- ▶ ▶ For additional information and conditions that may cause the Speed Limiter to activate, see **“Speed Limiter”** in the Reference Manual.

Stick Shake Warning

One of the ways that the Segway PT notifies you when you are at risk of falling is by shaking the Handlebar and making growling noises. This is called the Stick Shake Warning.

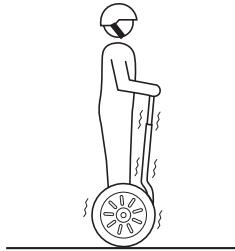

If the Stick Shake Warning occurs while riding, slow down. If the Stick Shake Warning persists, come to a stop and safely step off. Do not attempt to ride again until the condition that caused the persistent Stick Shake Warning has been identified and corrected.

If the Stick Shake Warning occurs while you are stopped or stuck, step off immediately and do not attempt to ride again until:

- You are clear of all obstacles and slopes.
- You are certain that you did not experience a Safety Shutdown.
 - ▶ ▶ For additional information, see **“Safety Shutdown” on page 42.**



WARNING!

Never let go of the Segway PT when it is in Balance Mode because it will travel some distance on its own, give the Stick Shake Warning, and then cut power to the Wheels. If you let go of a Segway PT while in Balance Mode, you risk injury to others and damage to the Segway PT.

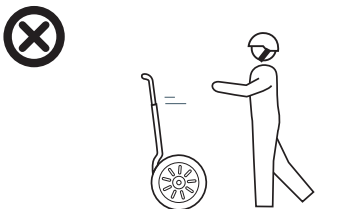

- ▶ ▶ For additional information and conditions that may cause the Stick Shake Warning to occur with or without a rider standing on the Mats, see “**Stick Shake Warning**” in the Reference Manual.

Safety Shutdown

If the Segway PT detects a fault in any of its redundant systems or a Battery is depleted beyond its safe limit, it performs a Safety Shutdown.

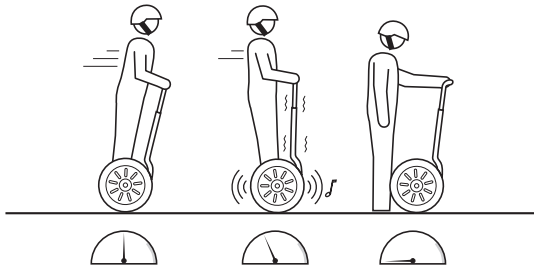

When a Safety Shutdown occurs, the Segway PT automatically reduces its speed, gives the Stick Shake Warning (shakes the Handlebar and makes growling noises), flashes the Balance Indicator lights, emits a warning tone, and the InfoKey Controller displays an unhappy face.

You have approximately 10 seconds from the start of a Safety Shutdown to come to a controlled stop and step off. After 10 seconds, the Segway PT will immediately shut down when the Wheels reach zero speed.

If a Safety Shutdown occurs:

1. Immediately come to a controlled stop.
2. Carefully step off one foot at a time.



WARNING!

Never restart and ride your Segway PT after it has indicated an empty Battery condition or performed Safety Shutdown due to low Battery. The Segway PT may not have enough power to keep you balanced, especially if you demand a lot of power at once. If you restart and continue riding, you risk falling. Also, you risk damaging your Batteries, resulting in reduced Battery life and capacity.

**WARNING!**

Theft detection systems, such as the type used in some libraries and retail stores can interfere with the Segway PT's ability to balance and/or cause the Segway PT to perform a Safety Shutdown. Do not ride within 5 feet (1.5 meters) of any theft detection system.

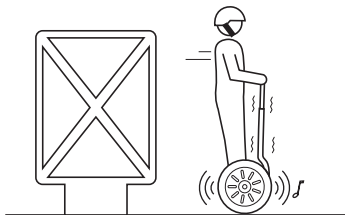



WARNING!

Do not get back on the Segway PT after a Safety Shutdown until the condition that caused the Safety Shutdown has been identified and corrected.

- ▶ ▶ For additional information about demonstrating a Safety Shutdown for training purposes, see “**Safety Shutdown**” in the Reference Manual.

Understanding Balance Mode

You ride your Segway PT in Balance Mode. In this mode, the Segway PT detects when you lean forward or backward, or tilt the LeanSteer Frame left or right, and it moves its Wheels in response to your movements.

The Segway PT also has a Riderless Balance Mode, which allows you to slowly move the Segway PT when you are not riding it. Step down off the Segway PT, and walk with your Segway PT in Riderless Balance Mode to move around obstacles, stairs, or terrain that is difficult to navigate. When the Segway PT is in Riderless Balance Mode, it is important to hold onto the Handlebar to prevent the Segway PT from moving on its own.

You know your Segway PT is in Balance Mode or Riderless Balance Mode when the Balance Indicator lights on the forward part of the Console are pulsing or rotating green and your InfoKey Controller displays a happy face.

- ▶ ▶ For information on how to put your Segway PT into Balance Mode, see **“Riding Your Segway PT” on page 59.**

Understanding the Rider Detect Sensors

The Segway PT has four sensors located beneath the Mats. Rider Detect Sensors detect the presence or absence of a rider while the Segway PT is powered on.

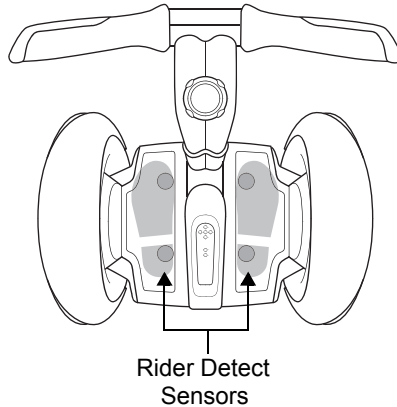

When your feet are properly positioned on the Mats, all four Rider Detect sensors depress, allowing the Segway PT to operate normally in Balance Mode.

If fewer than three Rider Detect sensors are depressed while riding, the Segway PT reduces the top speed limit regardless of whether Beginner Setting is enabled or not. Once your feet are properly positioned again, the Segway PT regains full performance.

If the Segway PT is moved too quickly while in Balance Mode and none of the Rider Detect Sensors are depressed, the Segway PT will give the Stick Shake Warning before exiting Balance Mode and transitioning to Standby Mode.

For additional information on Balance Mode and Standby Mode, see **“Stick Shake Warning” on page 38**.



WARNING!

Never place anything on the Mats, except your feet. Doing so could interfere with the Rider Detection system and allow the Segway PT to travel on its own, risking running into a person or property, and causing injury or damage.

Riding Guidelines

Riding Form

Your posture and stance affect your ability to ride safely:

- Be alert. Scan both far ahead and in front of the Wheels—your eyes are your best tool for safely avoiding obstacles and slippery surfaces.
- Keep a firm grip on the Handlebar, your legs loose, and knees and elbows bent. This helps you maintain your balance over rough terrain.

- Leave a gap between yourself and the Handlebar. Do not lean over or into the Handlebar. Leaning over or into the Handlebar dramatically increases the risk of collisions, falls, and loss of control.
- Keep your feet centered on the Mats.
- Practice controlled stopping.
- Keep your body aligned with the LeanSteer Frame and lean into turns.
- Point the LeanSteer Frame in the direction you want to travel.
- Make sure the Handlebar is set to the correct height.
 - ▶ ▶ For more information, see “**Adjusting the Handlebar Height**” on page 25.

Avoiding Hazards

The Segway PT is highly maneuverable and allows you to easily navigate around obstacles. However, to prevent the loss of traction, you must always be careful when riding and learn to identify and avoid slippery, icy, or wet surfaces, loose materials (sand/gravel), steep slopes, and obstacles.

Stop and step off your Segway PT and use Riderless Balance Mode to move your Segway PT over unsafe surfaces or terrain.

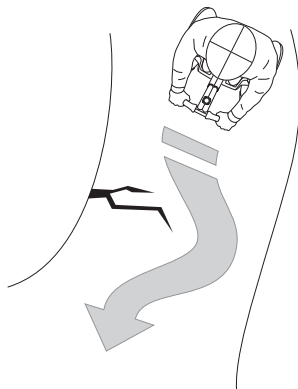

Avoiding Slips

The Segway PT Tires must be able to grip the ground for the machine to stay upright!

Slips occur when the Segway PT loses traction, potentially causing loss of control and a fall. Abrupt maneuvers, and riding over slippery surfaces, loose objects and materials, or steep slopes can cause the Segway PT to lose traction.

- Avoid abrupt maneuvers, such as fast stopping or starting.
- Avoid riding on slippery surfaces such as snow, ice, wet floors, wet grass, or any other surface that might cause slipping.
- Avoid riding over loose objects or materials such as small branches, litter, or small stones.
- Use caution when riding over any terrain change such as pavement to grass, or over a threshold or speed bump.
- Avoid riding on steep slopes.
- Maintain Tire contact with the ground.

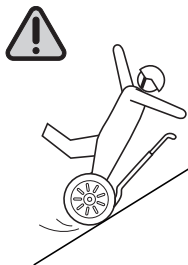
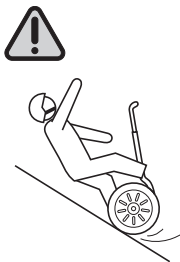

Avoiding Trips

Trips occur when the Segway PT's Wheel or Powerbase encounters an obstacle or terrain change that prevents the Segway PT from moving, bringing it to an abrupt stop and potentially causing a fall.

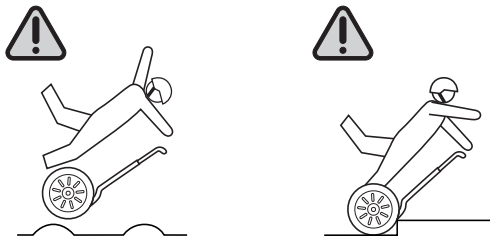

- Avoid holes, curbs, steps, and other obstacles.
- Avoid riding over any surface where the bottom of the Segway PT may strike any object.
- Use caution when riding over any terrain change such as pavement to grass, or over a threshold or speed bump.

Avoiding Tips

The Segway PT balances front to back but not side-to-side.

You are responsible for maintaining side-to-side balance by leaning into turns. If you fail to actively maintain this side-to-side balance, the Segway PT can tip sideways and fall.

- Avoid riding across steep slopes.
- Lean into turns and lean uphill when riding across gentle slopes.

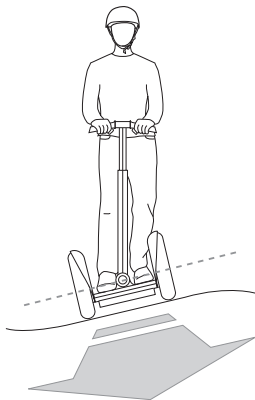

- Keep the LeanSteer Frame vertical when riding across a slope.
- Avoid turning on slopes or ramps.
- Never let go of the Handlebar when riding across a slope. The Segway PT will turn downhill and you could lose your balance.
- Stay centered on narrow sidewalks or elevated paths.
- Avoid turning when maneuvering backward.
- Make sure that one Wheel does not drop off a curb.



Riding Your Segway PT

This section describes how to ride the Segway PT. It discusses riding for the first time and helpful hints for all rides.

Follow these steps to learn to ride your Segway PT. It is important that you practice riding in a controlled, familiar environment until you are comfortable using your Segway PT and InfoKey Controller.

Before riding, make sure your Segway PT is assembled and charged.

- ▶ ▶ See **“Assembling Your Segway PT” on page 14**, and **“Charging the Batteries” on page 27**

Inspect your Segway PT before each use. Do not ride if any part is loose, damaged, or if Tires are not properly inflated.

- ▶ ▶ See **"Operating and Maintaining Your Segway PT"** in the Reference Manual.

Do not wear loose clothing or jewelry that could get caught in the Segway PT.

Step 1: Preparing for Your Ride

To prepare for your first ride:

1. Select an appropriate area for your first ride. This area may be indoors or outdoors and should measure at least 12 feet by 12 feet (4 meters by 4 meters). It must have a level, smooth riding surface with good traction and should be free of obstructions and away from vehicles, bicycles, pets, small children, and other distractions.



2. You will need a spotter who has studied all the instructions and warnings in this manual and the Safety Video to help you and assist you with the instructions.
3. Put on your helmet and fasten and adjust the chin strap in accordance with the manufacturer's instructions.

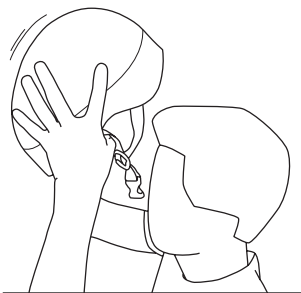

4. Move the Segway PT to the center of the riding area.

5. Adjust the Handlebar height.
 - ▶ ▶ For additional information, see “**Adjusting the Handlebar Height**” on page 25.
6. Acquaint yourself with the icons that may be displayed on the InfoKey Controller.
 - ▶ ▶ For additional information, see “**Using the InfoKey Controller**” on page 8.

Step 2: Powering On the Segway PT

Using the InfoKey Controller, power on your Segway PT by pressing the Power/Standby button. The Power/Standby button is located on the bottom left-hand side of the InfoKey Controller.

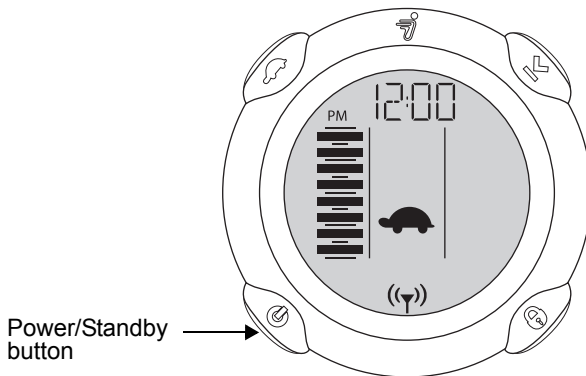

You will hear a tone from the Segway PT and the Balance Indicator lights (located on the Console) will illuminate to indicate the power is ON and the Segway PT is in Standby Mode.

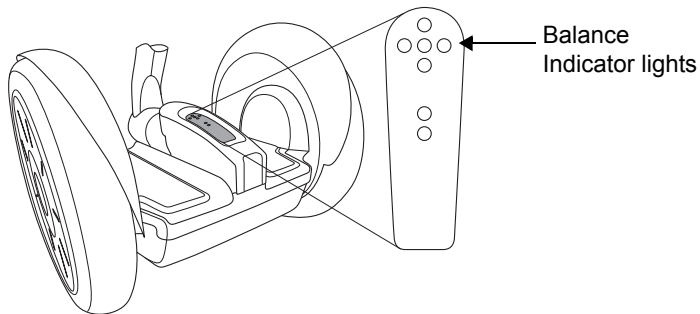

WARNING!

Do not step onto the Segway PT yet! Your Segway PT is powered on, but it is not balancing.

Step 3: Confirming the Beginner Setting

Ensure that the Beginner Setting is enabled by confirming that the Turtle icon shows on the InfoKey Controller display.



WARNING!

For your first ride, the Segway PT is set to operate exclusively with the Beginner Setting enabled. If the Turtle icon does not display, do NOT ride the Segway PT until you enable the Beginner Setting. See “InfoKey Controller Buttons and Display” on page 9.

- ▶ ▶ For additional information on what to do if you do not see the Turtle icon on the InfoKey Controller display, see **“Configuring and Locking the Beginner Setting”** in the Reference Manual.

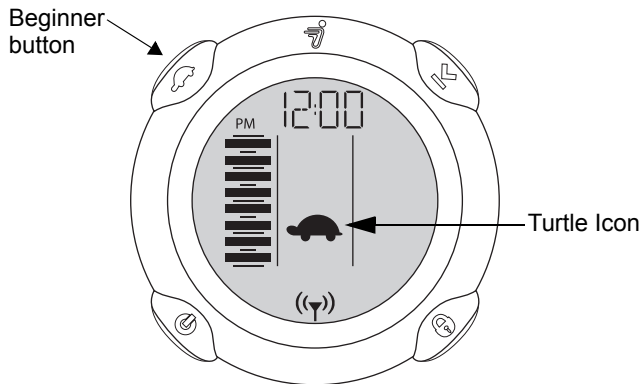



WARNING!

Do not step onto the Segway PT Powerbase yet! Your Segway PT is powered on, but it is not balancing.

Step 4: Before Stepping On

Your Segway PT is on, but it is not balancing. While standing behind the Segway PT, center the Handlebar and level the Powerbase. Use the Balance Indicator lights to help you. If any of the four outer Balance Indicator lights are red, tilt the Powerbase or Handlebar in the opposite direction of the light(s). When the Segway PT is ready to enter Balance Mode, the center Balance Indicator light will light up green. Make sure your InfoKey Controller is installed in the Dock prior to stepping on.

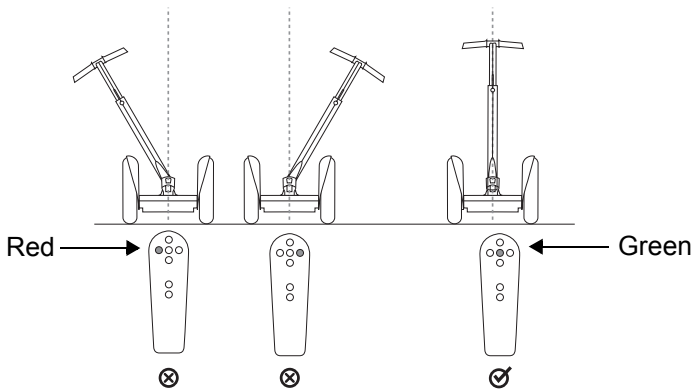

When the center Balance Indicator light is green, the Segway PT is ready for you to step onto the Mats.

Step 5: Stepping On

Before you attempt to step on for the first time:

- Have your spotter stand in front of the Segway PT, face you, and hold the Handlebar securely with both hands. Your spotter should be prepared to firmly hold the Segway PT to keep it from moving.
- Remember, the Segway PT will move forward, backward or turn if you move the Handlebar. Avoid pushing, pulling, or leaning the Handlebar as you step on.
- Confirm the center Balance Indicator light is green.

To step onto the Segway PT:

1. Hold the Handlebar with both hands, and as you step up, look forward and not down.

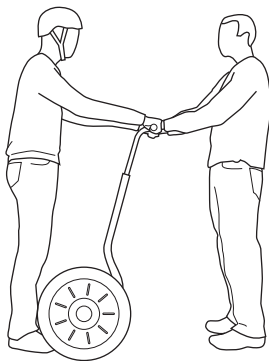

2. Place just one foot on the Mat.

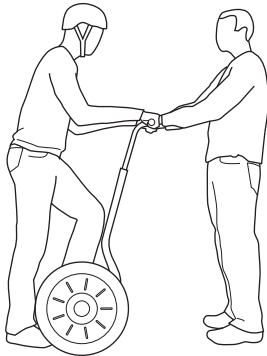

3. Slowly transfer your weight to your foot on the Mat.

4. Slowly, while avoiding moving the Handlebar, raise your back foot off the ground and place it on the Mat. Stay calm and relaxed. Look forward.



NOTE:

Be prepared. Some people rock back and forth involuntarily when they first step on.

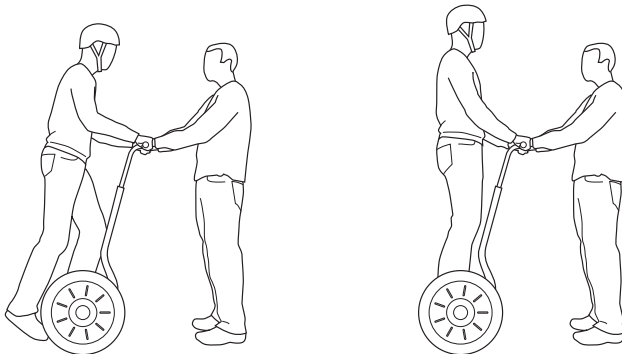

5. If you feel unstable, step off the Segway PT, one foot at a time, and pause before stepping back on.

The spotter should continue holding firmly the entire time, and be prepared to keep the Segway PT from moving as you step on or off.



The following shows the displays that appear on the Console and the InfoKey Controller as you step onto the Segway PT.

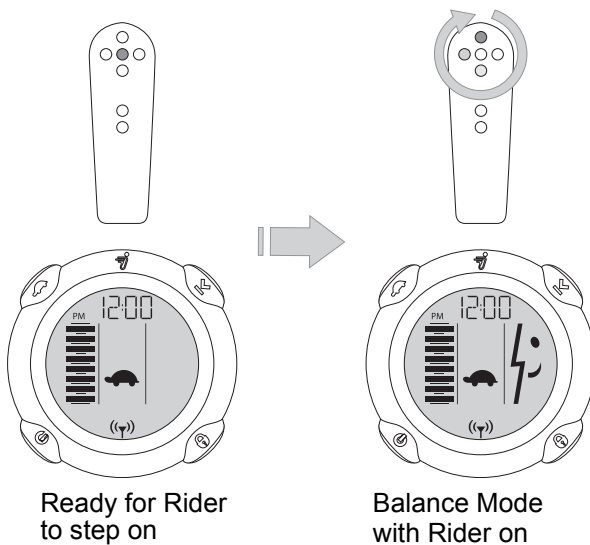

Keep the Powerbase level to remain stationary. The correct position for standing in place is shown as follows:

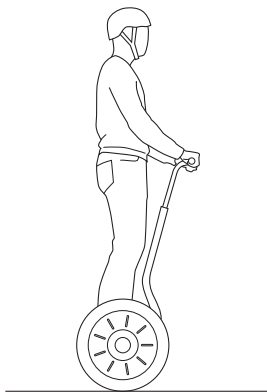

Step 6: Moving Forward and Backward

The Segway PT moves forward and backward in response to changes in your position.

When standing on the Powerbase, to move forward or backward:

1. With your spotter available to assist you, slowly lean forward and feel the Segway PT move forward. Then stop leaning forward and feel it slow down and stop. Do this a few times.

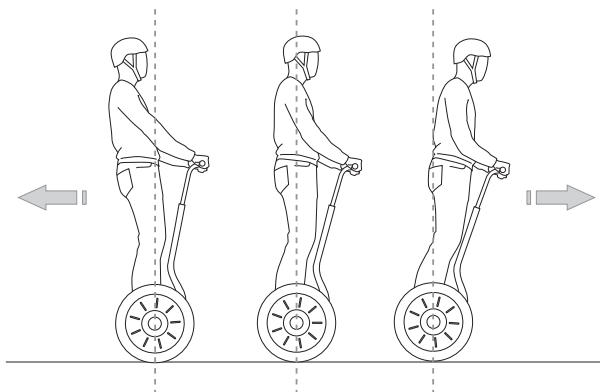



WARNING!

Avoid rocking back and forth or shifting your weight abruptly, as this could result in a loss of traction and cause a fall.



2. Look behind you and then slowly lean back and feel the Segway PT move backward. Then stop leaning back and feel it slow down and stop. Do this a few times.

**NOTE:**

You should not ride backward except to maneuver a few feet. Instead, turn and ride forward.

3. With your spotter standing close by, practice going forward and backward a short distance in each direction. Be careful not to run the Wheels into any wall or object. This could cause you to fall.
-

**WARNING!**

Do not turn or go fast when maneuvering backward.

Step 7: Stopping

Stop the Segway PT by shifting your weight away from the direction you are moving.

To stop the Segway PT:

1. When you are moving forward, gently shift your hips back (as if you are preparing to sit down) to bring the Segway PT to a stop.
2. Once stopped, center your weight over the Powerbase to remain stationary. If you continue to lean back, you will move backward.
3. Practice choosing a spot on the ground, and coming to a smooth controlled stop at that spot. Then remain stationary.

**WARNING!**

Avoid abrupt stops and slippery surfaces. Stopping abruptly, especially on slippery surfaces, can cause the Segway PT's Tires to lose traction, and you could fall.

**NOTE:**

Use a sit-down motion to stop by keeping your shoulders aligned over your hips and shifting your weight backward.

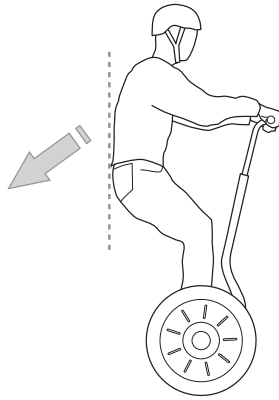



WARNING!

- **Always perform a controlled stop. Avoid abrupt stops. Come to a controlled stop by gently shifting your weight away from the direction of movement.**
 - **Avoid slippery surfaces. The Segway PT's Tires could lose traction causing you to fall.**
 - ▶ ▶ **For additional information, refer to the Safety Video.**
-

Step 8: Turning the Segway PT

The Segway PT turns in the direction that you lean the Handlebar. You turn the Segway PT by leaning the Handlebar left or right.

Turning In Place

First, practice turning in place. To turn in place, slowly pivot the Handlebar to the side in the direction that you want to turn. The Segway PT will rotate so that you turn in place. Practice turning to the right and to the left using this technique.

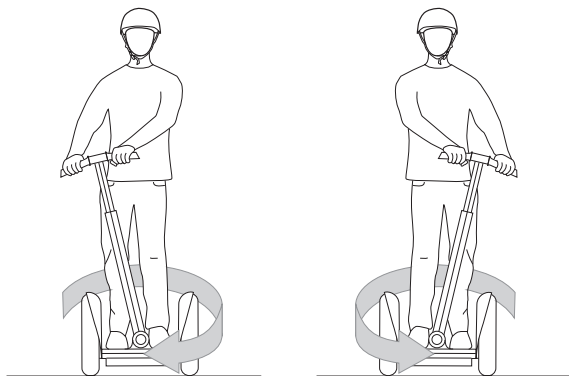

Turning While Moving

After you are comfortable going forward and backward and turning in place, try slowly riding forward and turning at the same time. Keep your knees slightly bent and lean in the direction of the turn in coordination with the angle of the LeanSteer Frame. Keep your body aligned with the LeanSteer Frame while turning.

Because abrupt turns can be dangerous, always lean into turns slowly and smoothly.

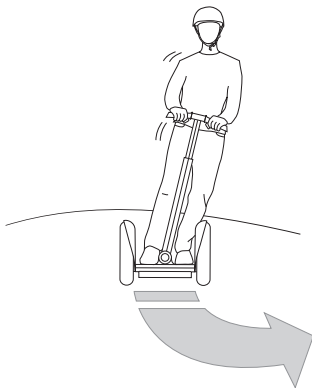

Step 9: Stepping Off

When you are ready to step off the Segway PT for the first time, your spotter should hold the Handlebar.

Remain stationary by keeping your weight centered over the Wheels and Powerbase and keep the Handlebar vertical.

To step off the Segway PT:

1. Without leaning backward or to the side, step off the Segway PT, one foot at a time.



WARNING!

Be careful not to pull back or turn the Handlebar while you are stepping off the Segway PT.

2. After you have stepped off, continue to hold the Handlebar in place. If you let go, the Segway PT will roll forward and can potentially cause injury or damage.

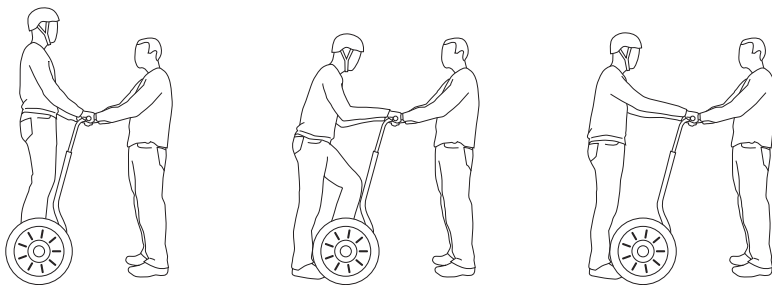

WARNING!

Do not pull the Segway PT towards you as you step off.

3. When you step off, the Segway PT enters Riderless Balance Mode. In Riderless Balance Mode, the Segway PT moves forward, backward and turns in response to how you move the Handlebar. Use Riderless Balance Mode to move the Segway PT over curbs or terrain where it is unsafe or undesirable to ride.

The following shows the Balance Indicator lights and the InfoKey Controller display as you step off the Segway PT.

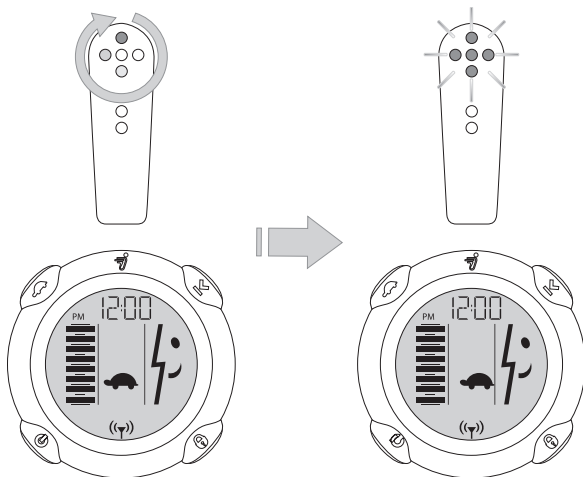

Rider on
in Balance Mode

Rider off in
Balance Mode
(Riderless Balance
Mode)



NOTE:

If you move too fast in Riderless Balance Mode, the Segway PT will give the Stick Shake Warning, and transition to Standby Mode.

Step 10: Securing Your Segway PT

The Segway PT provides a Security function in case you need to leave your Segway PT unattended. The Security function includes an alarm and uses the motors to make it difficult to move your Segway PT.

The best way to discourage tampering with your Segway PT is to keep it in a secure indoor location with the InfoKey Controller stored separately. The Security function is intended for use when you remain in the general area of the Segway PT, and are able to respond to an alarm. If you must leave your Segway PT unattended in a location that is not secure, activate the Security function with your InfoKey Controller and use a lock.

To set the Security function:

1. Step off your Segway PT.
2. Press the Security button on the InfoKey Controller.

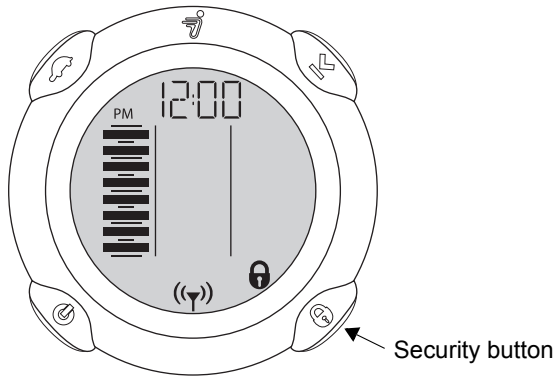

3. The Segway PT provides an audio indication that the Security function is activated and a lock icon displays on the InfoKey Controller:



Be sure to take your InfoKey Controller with you (do not leave it with the Segway PT).

4. To deactivate the Security function, press the Security button on the InfoKey Controller. The Lock icon on the InfoKey Controller disappears and the Security function is no longer activated.

Step 11: Powering Off the Segway PT

1. Power off the Segway PT by pressing and holding the Power/Standby button on the InfoKey Controller for two seconds.

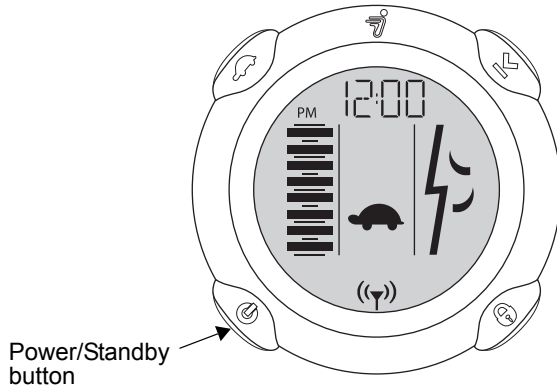

2. The display on the InfoKey Controller will show a sleepy face and the Segway PT will emit a tone as the Segway PT powers off.

Practice Riding

You will need to become very familiar with your Segway PT before you attempt to ride outside of your controlled practice environment. The more you practice, the safer you will be when you move into new places. Remember the following as you practice:

- Use the Beginner Setting and ride in areas free of obstacles and distractions until you are comfortable on your Segway PT. Practice at the Beginner level until you can step on, ride forward and backward, turn, stop, and step off with the same precision and confidence as you walk.
- With practice, you should be able to ride in narrow areas. You should also be able to ride, turn, and stop on a narrow, curving, paved walkway.

- Until you can ride with this precision, do not attempt to ride in any area where you might encounter children, pedestrians, pets, vehicles, bicycles, or other obstacles and potential hazards.
- Your first rides without the Beginner Setting should be in the same secure areas where you learned to ride with the Beginner Setting.
- Use caution when riding in new environments.
- Be careful when riding through a doorway.

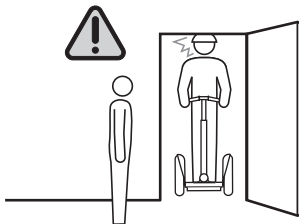

- Make sure you leave enough Wheel clearance.



- Watch out for terrain transitions such as pavement and grass.

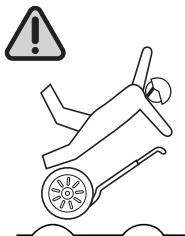

Navigating Terrain

With practice, you can learn to ride over many different types of terrain, provided you avoid slippery surfaces, loose materials, steep slopes, and obstacles. Always proceed slowly over unfamiliar terrain.

Never allow the Segway PT to become airborne, even for short periods of time, because the Segway PT has no traction when airborne, and you could lose control upon landing.

Terrain Compensation

The Segway PT is designed to compensate for uneven terrain. When riding straight on uneven terrain, keep the LeanSteer Frame vertical.

Point the LeanSteer Frame in the direction you want to move and allow the Powerbase to follow the contour of the ground.

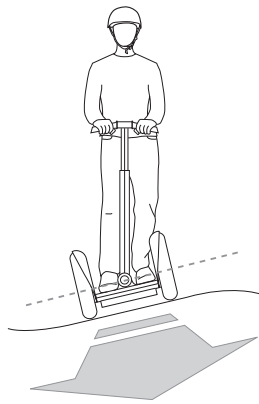

Navigating Stairs and Curbs

1. Step off of the Mats.
2. Check the Console and verify the Segway PT is in Riderless Balance Mode.
3. Walk around so you are in front of the Segway PT.
4. Carefully guide the Segway PT to the stairs and align the Wheels perpendicular to the stairs or curb.
5. Always stand above the Segway PT, facing the Handlebar. Gently guide the Segway PT up or down, one step at a time.

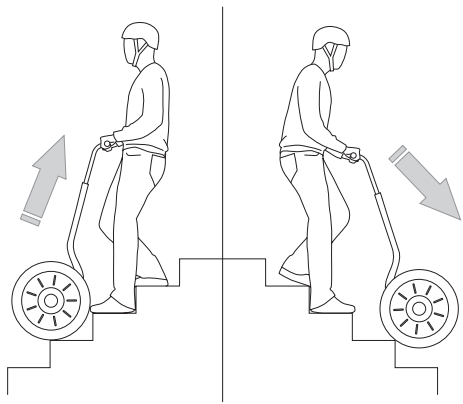



WARNING!

If the Wheels slip while guiding the Segway PT up or down stairs or curbs, the Segway PT may exit Riderless Balance Mode and enter Standby Mode. The Segway PT will not “assist” you in moving up or down the stairs while in Standby Mode. Slowly and carefully guide your Segway PT down the stairs. Re-enter Riderless Balance Mode before you try again.

**WARNING!**

Keep the Segway PT below you at all times. Lead it up stairs, curbs, and slopes and keep it below you when descending stairs, curbs, and slopes.

Never attempt to ride the Segway PT up or down stairs or curbs.

Riding Etiquette

Use proper etiquette when riding your Segway PT.

- Be careful and considerate of others.
- Always ride under control at a speed that is safe for you and those around you.
- Always be prepared to stop.
- Respect pedestrians by always yielding the right of way.
- Avoid startling pedestrians. When approaching from behind, announce yourself and slow down to walking speed when passing. Pass on the left whenever possible. When approaching a pedestrian from the front, stay to the right and slow down.
- In heavy pedestrian traffic, slow down and proceed at the pace of pedestrian traffic. Pass only if there is ample space to do so safely. Do not weave in and out of pedestrian traffic.

- When riding with other Segway PT riders, maintain a safe distance, identify hazards and obstacles, and do not ride side-by-side unless there is plenty of room left for pedestrians.
- Do not park your Segway PT in a way that blocks pedestrian traffic.
- Cross roads at designated crosswalks or signaled intersections. Do not jaywalk/ride.
- Only travel on a road when a pedestrian way is not available or when sidewalk use is not allowed.
- Do not ride your Segway PT on private property (inside or outside) unless you have obtained permission to do so.
- Learn about and obey applicable laws and regulations.

Safety Tips and Guidelines

The Segway PT's unique balancing ability and ease of use can lead you to become overconfident. If you exceed the ability of the Segway PT to balance, such as by riding over obstacles, uneven terrain, slippery surfaces, loose materials, or steep slopes, you can very quickly lose control, leading to collisions, falls, and injury. As with any other transportation device, using a Segway PT exposes you to risk of injury. You can reduce the risk by following all the instructions and warnings in this Manual, but you cannot eliminate the risk.

- Read this Manual and watch the Safety Video.
- Do not allow any person to use your Segway PT unless that person has carefully read this Manual and watched the Safety Video.

- Wear a helmet. Whenever you ride your Segway PT wear a helmet that fits properly with the chin strap in place. Use an approved bicycle or skateboard helmet that provides protection for the back of your head. Depending upon riding conditions and your riding experience, consider using additional protective equipment, such as gloves, eye protection, wrist guards and knee pads. Wear footwear that protects your feet and provides adequate support and comfort.
- Spot new riders carefully. All new riders should use the Beginner Setting. The safety of new riders is your responsibility. Do not allow anyone to step onto the Segway PT for the first time unless you are there to hold the Handlebar. Spot new riders until they are comfortable with the basic operation of the Segway PT. Do not let new riders operate the Segway PT outside of your direct supervision unless they have read this Manual and watched the Safety Video.

- Avoid slippery surfaces, loose materials, steep slopes, and obstacles. If you cannot avoid a slippery surface, loose material, steep slope, or obstacle, then you must step off and use Riderless Balance Mode to move across it. Be especially careful when riding in confined spaces or near obstructions.
- Use caution on slopes. Use caution when ascending, descending, or crossing slopes. Do not attempt to ride across any slopes with loose material or slippery surfaces. Instead, step off and use Riderless Balance Mode, walking with the Segway PT held downhill from you. When riding across any slope, lean uphill to maintain balance.
- You are taller than you think. Be aware of the added height that the Segway PT (and your helmet) gives you and use caution when riding indoors or in the vicinity of doorways, archways, branches, signs, or other low overhead obstacles.

- Watch those turns! Always turn slowly and with caution. Fast turns can lead to loss of control and falls. Lean into turns.
- Do not take risks. When you encounter a slope, uneven terrain, or other terrain feature with which you are not experienced or that makes you at all concerned about your safety, do not risk riding over it. Instead, step off and use Riderless Balance Mode.
- Do not wear loose clothing that can catch in the Tires and prevent proper steering.
- No passengers. The Segway PT is for one rider. Do not ride double or carry any passengers. Do not carry a child in your arms or in a child carrier while riding.

- The Segway PT has not been designed, tested or approved as a medical device. You must be able to step on and off the Segway PT unassisted, which requires physical abilities similar to ascending and descending stairs without assistance, and without holding the handrail.
- When riding, keep both hands on the Handlebar and both feet on the Mats. Do not attempt to carry any object in your hand(s). If you need to carry any object, use a cargo accessory that is recommended by Segway or a securely attached backpack with both shoulder straps in place.

- Never ride on stairs or through revolving doors. Riding on stairs is extremely dangerous, as is riding on escalators and through revolving doors.
- Do not step off a moving Segway PT. Always come to a stop before stepping off.
- Do not ride in the dark. Do not ride the Segway PT in low visibility conditions without a light. To ride safely, you must be able to clearly see what is in front of you and you must be clearly visible to others.
- Be relaxed. Ride in a relaxed position with your knees and elbows slightly bent and head up.

- Be prepared to stop. Be especially careful when approaching or crossing intersections, driveways, corners, doorways, and other areas where you may need to slow down or stop to avoid motor vehicles, bicyclists, or pedestrians.
- Be alert. As with any other transportation device, you must be mentally alert to safely ride a Segway PT. Do not attempt to ride if you are ill or if you cannot comply fully with the instructions and warnings in this Manual. Do not ride under the influence of alcohol or drugs.
- Avoid distractions. Do not use a cell phone, listen to headphones, or engage in any other activity that might distract you or interfere with your ability to monitor your surroundings while riding.

- Do not ride backward. You should not ride backward, except to maneuver a few feet. Instead, turn and ride forward. There is a difference between maneuvering backward and riding backward, similar to the difference between stepping back and walking backward. Maneuver backward only when necessary to open a door or back away from an obstacle.



- Avoid turning while maneuvering backward.

- Never restart and ride your Segway PT after it has indicated an empty Battery condition or performed a low Battery Safety Shutdown. The Segway PT may not have enough power to keep you balanced, especially if you demand a lot of power at once. If you restart and continue riding, you risk falling. Also, you may damage your Batteries resulting in reduced Battery life and capacity.
- Never let go of a balancing Segway PT. Never let go of your Segway PT when in Balance Mode, because the Segway PT will travel some distance on its own before transitioning to Standby Mode. The Segway PT will not travel very far if you let go of it when it is stopped. But, if you let go of it when it is moving at any speed, it could travel much farther, risking injury to others and damage to the Segway PT.

- Riding on the road. The Segway PT is not intended or recommended for primary use on roads. If you must ride on the road, or must cross the road, be extremely careful. Ride as far away from traffic as possible. Allow plenty of time for crossing roads. Remember, the Speed Limiter or an unexpected obstacle could slow your crossing. Check to make sure that riding on the road is allowed by law.
- Carrying cargo. To carry cargo, use a cargo accessory that is recommended by Segway or a securely attached backpack with both shoulder straps in place. Do not place cargo (or any object) on the Powerbase. The total weight of any Handlebar payload plus any other attachments hanging from the Handlebar should not exceed 10 lbs. (4.5 kg). Exceeding this limit interferes with the Segway PT's balancing ability and could cause the Segway PT to accelerate on its own, risking injury and damage.

- Leave a gap! Leave a gap between yourself and the Handlebar. Do not lean over or into the Handlebar. Leaning over or into the Handlebar dramatically increases the risk of loss of control, collisions, and falls.
- Do not exceed the maximum weight limit (rider and all cargo) specified in the Reference Manual. If you exceed the maximum weight limit, you are at greater risk of falling and injury, and damage to the Segway PT could result. Also, the rider's weight must not be less than the minimum rider weight limit specified in the Reference Manual. If you are below the minimum rider weight limit, you may not be able to ride safely because you cannot shift your weight far enough back (behind the center line of the Wheels) to safely slow down and stop, especially when riding downhill. Riders below the minimum weight limit might also fail to properly activate the Segway PT's Rider Detect Sensors.
 - ▶ ▶ For additional information on weight limits, see “**Operating Limits**” in the Reference Manual.

- Because safe riding of the Segway PT requires adherence to all the instructions in this Manual, Segway recommends that you not allow children to ride your Segway PT unless: (a) you have first learned to ride, so that you understand the care and skill required to ride safely; (b) the child has read this entire Manual and watched the entire Safety Video; and (c) you are satisfied that the child has the knowledge, maturity, and physical ability to ride safely without endangering him/herself or others. As a general rule, Segway recommends that riders be at least 16 years of age.
- Maintain Tire inflation pressure at the level stated in the “**Segway PT Specifications Table**” in the Reference Manual. If you exceed the Tire inflation pressure stated on the Wheel label, you increase the risk of loss of control, collisions, and falls. Lower pressure reduces range and risks Tire and Wheel damage.

- Make sure the Segway PT is powered off prior to lifting. Use safe and appropriate loading and lifting techniques. Segway recommends that two people work together to lift the Segway PT. Lift with your legs, not your back. Never lift the Segway PT by its Tires, Fenders, or Wheels because your hands or fingers could become caught between the Tire and the Fender, resulting in injury.
- Unplug before servicing. Disconnect your Segway PT from AC power before removing or installing Batteries or performing any other service.
 - ▶ ▶ For additional warnings and instructions regarding service, see “**Servicing Your Segway PT**” in the Reference Manual.

- Pre-ride inspection. Inspect your Segway PT before each use. Do not use if any part is loose or damaged.
 - ▶ ▶ If you discover any loose or damaged part, see “**Troubleshooting Procedures**” in the Reference Manual.
- Do not place any objects on the Mats. This could cause the Segway PT to move on its own when in Balance Mode.
- You could damage your Segway PT and render it unsafe to use.

- Avoid submersion. Do not submerge the Batteries or Powerbase in water. Do not wash the Segway PT with a power washer or high pressure hose. Avoid getting water in the Charge Port. Always close the Charge Port Cover after charging. Avoid exposure to heavy downpours or extended periods of heavy rain (including during riding, storage, or while being transported.)
 - ▶ ▶ If your Segway PT has been exposed to a heavy downpour or an extended period of rain, see the Reference Manual for instructions.

Clean with soap and water and a soft cloth. Make sure that the Charge Port is dry before you plug in the Power Cord.

- Do not open the Powerbase. There are no user-serviceable parts inside the Powerbase. By opening the Powerbase, you risk electric shock injury. Also, you could void your limited warranty, damage your Segway PT, and render it unsafe to use.
- Do not open the Gearboxes. There are no user-serviceable parts inside the Gearboxes. You could damage your Segway PT and render it unsafe to use.
- Do not use in hazardous atmospheres. The Segway PT has not been certified for use in hazardous atmospheres as defined in NFPA 70, National Electric Code. Hazardous atmospheres are locations where fire or explosion hazards may exist due to flammable gases, vapors, liquids, dust, or fibers.
- Follow the instructions in the Reference Manual for servicing your Segway PT.
- Be safe... and enjoy the ride.

Report All Incidents

If you or any other user of your Segway PT is involved in an accident, or if your Segway PT performs in a way that you do not intend or in a way that it is not supposed to, contact Segway Customer Operations. Phone: 1-866-4SEGWAY (1-866-473-4929) Fax: 1-603-222-6001 Email: technicalsupport@segway.com Website: www.segway.com

Consult the Reference Manual and Website

Segway also provides a detailed Reference Manual for your Segway PT, with important information about Displays, Battery charging, maintenance, troubleshooting, and other matters. Check the website for updates to Segway PT User Materials: www.segway.com.

